

Product Data Sheet 412 F/2H

**ebmpapst**

The engineer's choice



412 F/2H

INDEX

<b>1</b>	<b>General .....</b>	<b>3</b>
<b>2</b>	<b>Mechanics .....</b>	<b>3</b>
2.1	General .....	3
2.2	Connections .....	3
<b>3</b>	<b>Operating Data .....</b>	<b>4</b>
3.1	Electrical Operating Data .....	4
3.2	Electrical Interface - Output - Tacho .....	5
3.3	Electrical Features .....	6
3.4	Aerodynamics .....	7
3.5	Sound Data .....	8
<b>4</b>	<b>Environment.....</b>	<b>8</b>
4.1	General .....	8
4.2	Climatic Requirements.....	8
<b>5</b>	<b>Safety.....</b>	<b>9</b>
5.1	Electrical Safety .....	9
5.2	Approval Tests .....	9
<b>6</b>	<b>Reliability.....</b>	<b>9</b>
6.1	General .....	9

**1 General**

Fan type	Fan	
Rotating direction looking at rotor	Counterclockwise	
Airflow direction	Air outlet over struts	
Bearing system	Sleeve bearing	
Mounting position - shaft	Any	

**2 Mechanics**

**2.1 General**

Width	40,0 mm	
Height	40,0 mm	
Depth	10,0 mm	
Mass	0,017 kg	
Housing material	Plastic	
Impeller material	Plastic	
Max. torque when mounted across both mounting flanges	Wire outlet corner: 50 Ncm Remaining corners: 70 Ncm	
Screw size	ISO 4762 - M3 degreased, without an additional brace and without washer	

**2.2 Connections**

Electrical connection	Wires	
Lead wire length	L = 310 mm	
Tolerance	+ - 10,0 mm	
Wire size (AWG)	28	
Insulation diameter	1,40 mm	

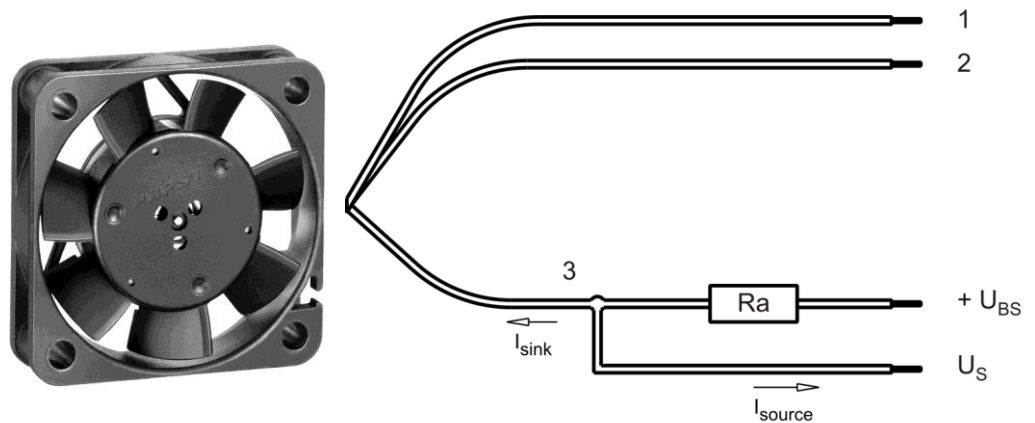

Wire	Color	Operation
1	red	+ UB
2	blue	- GND
3	white	Tacho

The auxiliaries shown on the schematic diagram (which are required for the intended use) are not part of our delivery.

### 3 Operating Data

#### 3.1 Electrical Operating Data

Measurement conditions: Normal air density = 1,2 kg/m<sup>3</sup>; Temperature 23°C +/- 3°C; Motor axis horizontal; warm-up time before measuring 5 minutes (unless otherwise specified). In the intake and outlet area should not be any solid obstruction within 0,5 m.

$\Delta p = 0$ : corresp. to free air flow (see section 3.5)  
I: corresp. to arithm. mean current value

Features	Condition	Symbol	Values		
Voltage range		U	10 V		14,0 V
Nominal voltage		$U_N$		12,0 V	
Power consumption	$\Delta p = 0$	P	0,6 W	0,8 W	1,1 W
Tolerance	0010		+/- 17,5 %	+/- 12,5 %	+/- 15,0 %
Current consumption	$\Delta p = 0$	I	60 mA	67 mA	80 mA
Tolerance	0010		+/- 17,5 %	+/- 12,5 %	+/- 17,5 %
Speed	$\Delta p = 0$	n	4.900 1/min	6.000 1/min	7.000 1/min
Tolerance	0010		+/- 15,0 %	+/- 10,0 %	+/- 15,0 %
Starting current consumption				137 mA	

3.2 Electrical Interface - Output - Tacho

Tacho type	/2 (open collector)
------------	---------------------

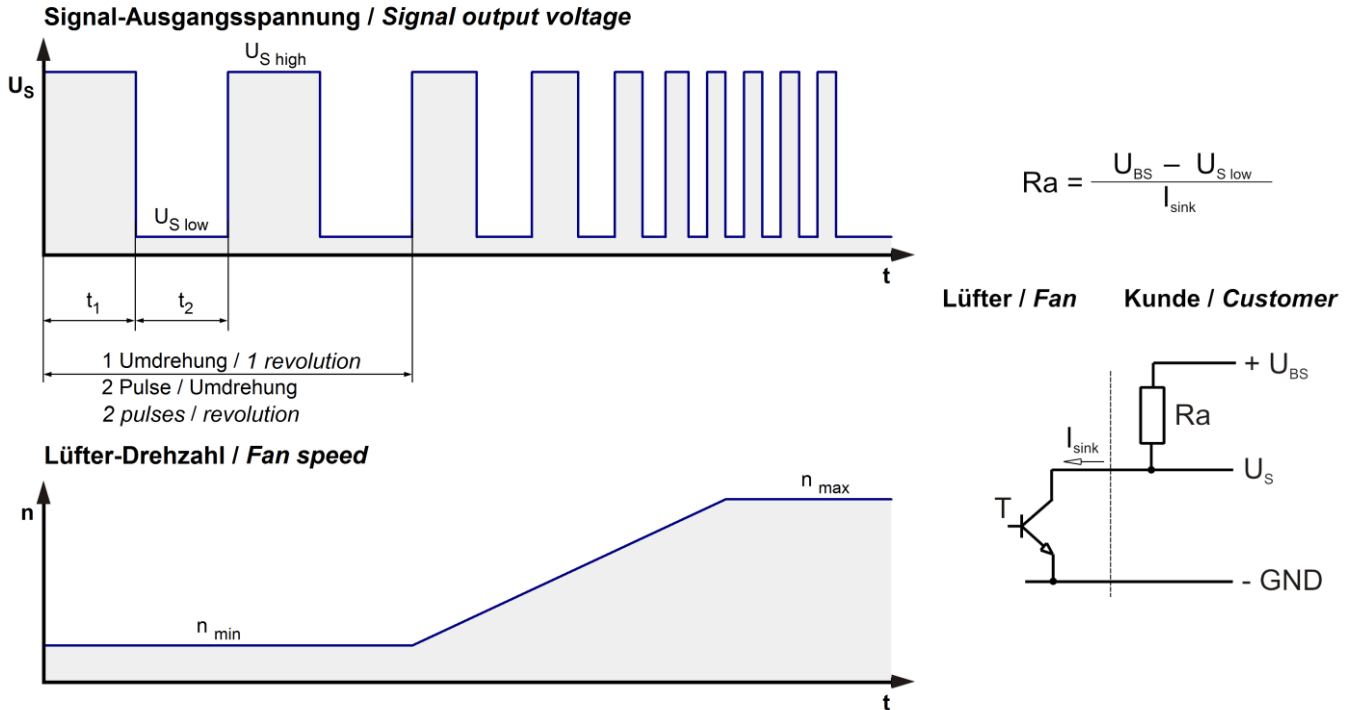

Features	Note	Values
Tacho operating voltage	$U_{BS}$	$\leq 30\text{ V}$
Tacho signal Low	$U_{S\ low}$	$\leq 0,4\text{ V}$
Tacho signal High	$U_{S\ high}$	$\leq 30\text{ V}$
Maximum sink current	$I_{sink}$	$\leq 2\text{ mA}$
Maximum source current		$0\text{ mA}$
External resistor	External resistor $R_a$ from $U_{BS}$ to $U_S$ required. All voltages measured to GND.	
Tacho frequency	$(2 \times n) / 60$	
Tacho isolated from motor	No	
Slew rate		$\Rightarrow 0,5\text{ V/us}$

n = revolutions per minute (1/min)

### 3.3 Electrical Features

Electronic function	None	
Reversed polarity protection	Rectifying diode	
Max. residual current at $U_N$	$I_F \leq 30 \text{ nA}$	
Locked rotor protection	Impedance protected	
Locked rotor current at $U_N$	$I_{\text{block}}$	

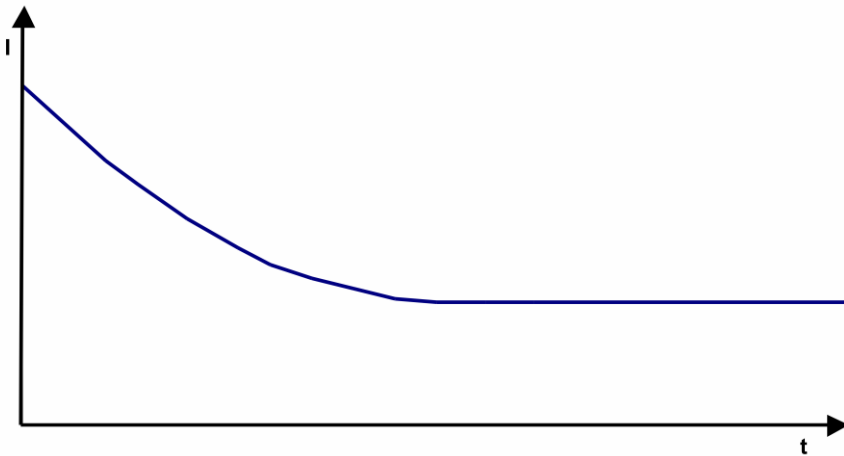

### 3.4 Aerodynamics

Measurement conditions: Measured with a double chamber intake rig.  
 Normal air density = 1,2 kg/m<sup>3</sup>; Temperature 23°C +/- 3°C;  
 In the intake and outlet area should not be any solid obstruction within 0,5 m.  
 The information is only valid under the specified test conditions and may be changed by the installation conditions. If there are deviations from the standard test conditions, the characteristic values must be checked under the installed conditions.

a.) Operation condition:

6.000 1/min at free air flow

Max. free-air flow ( $\Delta p = 0 / \dot{V} = \text{max.}$ )	10,0 m <sup>3</sup> /h	
Max. static pressure ( $\Delta p = \text{max.} / \dot{V} = 0$ )	40 Pa	

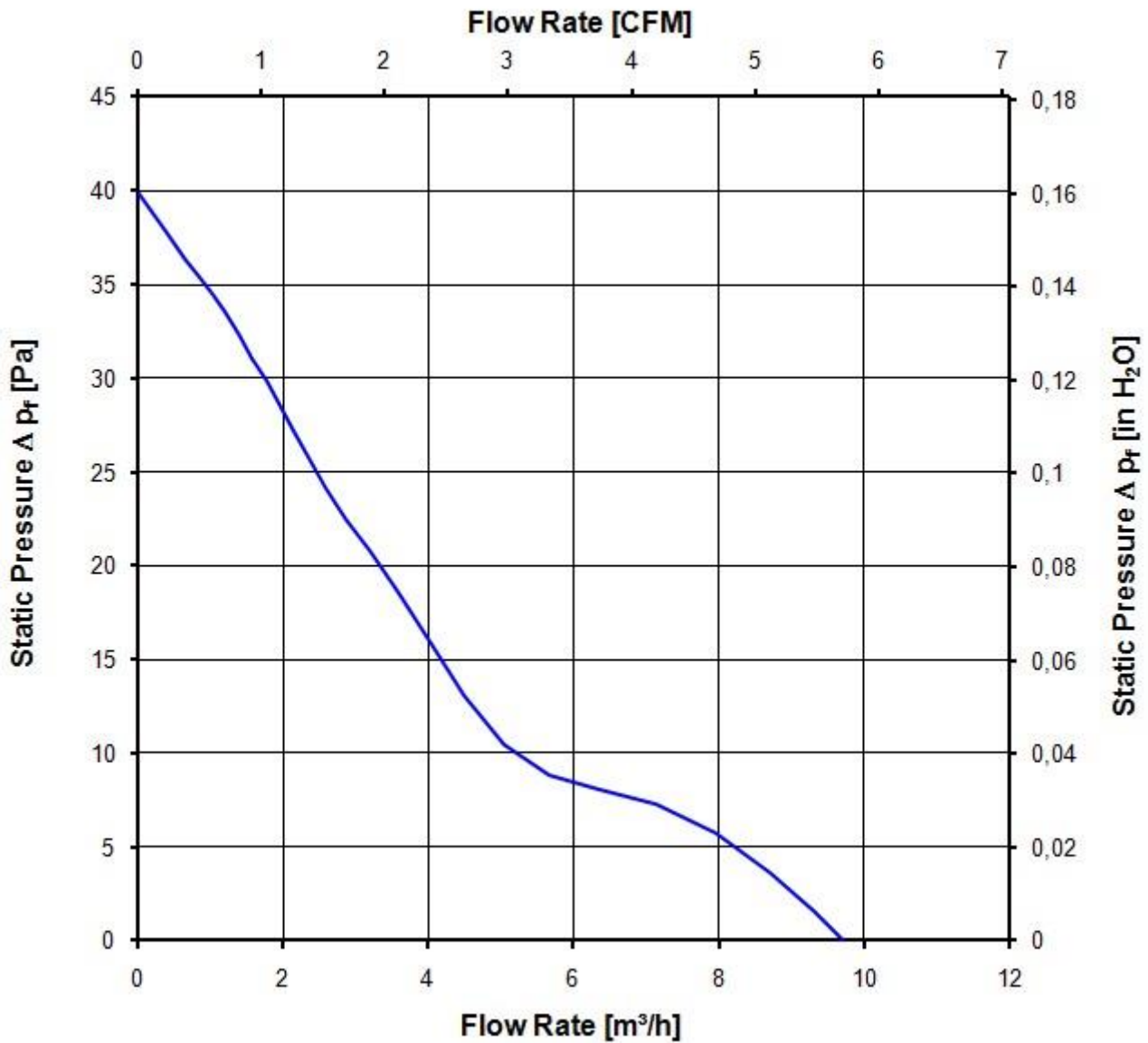

### 3.5 Sound Data

Measurement conditions: Sound pressure level: 1 meter distance between microphone and the air intake.  
 Sound power level: Acc. to DIN 45635 part 38 (ISO 10302)  
 Measured in a semianchoic chamber with a background noise level of  $L_p(A) < 5 \text{ dB(A)}$   
 For further measurement conditions see section 3.5

a.) Operation condition:

6.000 1/min at free air flow
------------------------------

Optimal operating point	10,0 m <sup>3</sup> /h @ 0 Pa	
Sound power level at the optimal operating point	4,4 bel(A)	
Sound pressure level at free air flow, measured in rubber bands	26,0 dB(A)	

## 4 Environment

### 4.1 General

Min. permitted ambient temperature TU min.	-20 °C	
Max. permitted ambient temperature TU max.	70 °C	
Min. permitted storage temperature TL min.	-40 °C	
Max. permitted storage temperature TL max.	80 °C	

### 4.2 Climatic Requirements

Humidity requirements	humid heat, constant; according to DIN EN 60068-2-78, 14 days	
Water exposure	None	
Dust requirements	None	
Salt fog requirements	None	

Permitted application area:

The product is intended for use in sheltered rooms with controlled temperature and controlled humidity. Directly exposure to water must be avoided.

Pollution degree 1 (according DIN EN 60664-1)

There is either no pollution or it occurs only dry, non-conductive pollution. The pollution has no negative impact.

Please require severity levels and specification parameters from the responsible development departments.



**5 Safety**

**5.1 Electrical Safety**

Dielectric strength DIN EN 60950 (VDE 0805) and DIN EN 60335 (VDE 0700) A.) Type test Measuring conditions: After 48h of storage at 95% R.H. and 25°C. No arcing or breakdown is allowed! All connections together to ground.	Not applicable	
B.) Routine test Measuring conditions: At indoor climate. No arcing or breakdown is allowed! All connections together to ground.	Not applicable	
Isolation resistance Measuring conditions: After 48h of storage at 95% R.H. and 25°C measured with U=500 VDC for 1 min.	RI > 10 MOhm	
Clearance / creepage distance	1,0 mm / 1,2 mm	
Protection class	III	

**5.2 Approval Tests**

CE	EC Declaration of Conformity	Yes
EAC	Eurasian Conformity	Yes
UL	Underwriters Laboratories	Yes / UL507, Electric Fans
VDE	Association for Electrical, Electronic and Information Technologies	Yes / Approval acc. to EN 60950 (VDE 0805) - Information technology equipment
CSA	Canadian Standards Association	Yes / C22.2 No. 113 Fans and Ventilators
CCC	China Compulsory Certification	Not applicable

The approval tests are observed to:

U approval max.:14,0 V @ TU approval max.: 70,0 °C

**6 Reliability**

**6.1 General**

Life expectancy L10 at TU = 20 °C	45.000 h	
Life expectancy L10 at TU = 40 °C	30.000 h	
Life expectancy L10 at TU = 60 °C	15.000 h	
Life expectancy L10 at TU max.	10.000 h	
Life expectancy L10 acc. to IPC 9591 at TU = 40 °C	50.000 h	

Copying of this document, and giving it to others and the use or communication of the contents thereof, are forbidden without express authority. Offenders are liable to the payment of damages. All rights are reserved in the event of the grant of a patent or the registration of a utility model or design.

Schutzvermerk nach DIN ISO 16016 beachten/  
Refer to protection notice DIN ISO 16016!

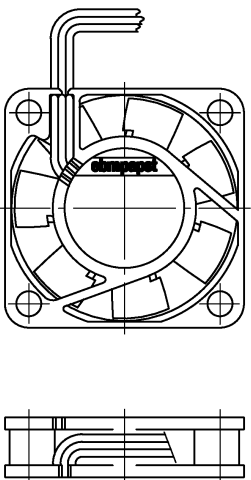
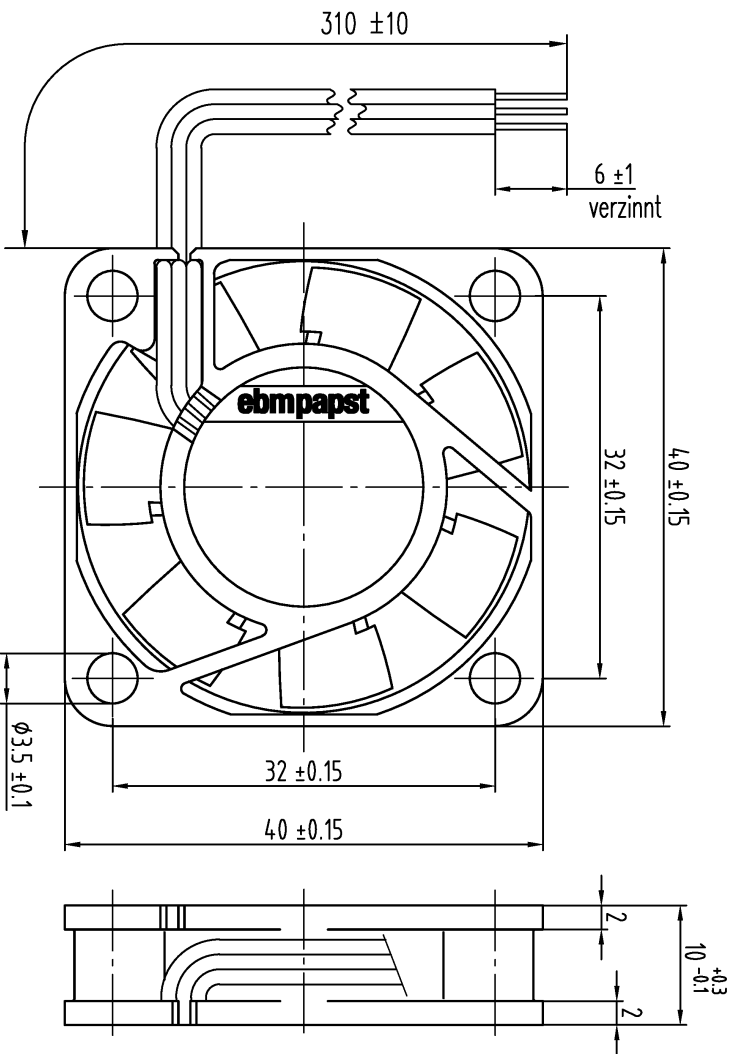

Tolerierung/Tolerances: **DIN 7167**  
Allgemeintoleranzen/  
gen. Tolerances:

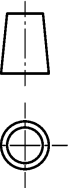
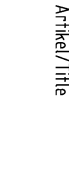
Datum/Date		Name/Name			Artikel/Title	Massstab/Scale
Bearb./Drawn		keine				
Index/Index		keine			Zchg.-Nr./ Dwg.-No.:	Blatt/Page
ggf. u. zur Verwendung freigegeben/Checked for release gen. by		keine				